

# Triple Power Lithium-ion Battery User Manual

45Ah/63Ah



## Solax Power Network Technology(Zhe jiang) Co., Ltd.

No.288 Shizhu Road, Tonglu Economic Development Zone,  
Tonglu City, Zhejiang province, China.

Tel: +86 0571-56260011

E-mail: info@solaxpower.com

614.00331.03

### Copyright Declaration

The copyright of this manual belongs to Solax Power Network Technology(Zhe jiang) Co., Ltd. Any corporation or individual should not plagiarize, partially or fully copy (including software,etc.), and no reproduction or distribution of it in any form or by any means. All rights reserved. Solax Power Network Technology (Zhe jiang) Co.,Ltd. reserves the right of final interpretation.

# CONTENTS

<b>1</b>	<b>NOTE ON THIS MANUAL.....</b>	<b>1</b>
1.1	SCOPE OF VALIDITY.....	1
1.2	TARGET GROUP.....	1
1.3	SYMBOLS USED.....	1
<b>2</b>	<b>SAFETY.....</b>	<b>2</b>
2.1	SAFETY INSTRUCTIONS.....	2
2.1.1	GENERAL SAFETY PRECAUTIONS.....	2
2.1.2	EXPLANATION OF SYMBOLS.....	3
2.2	RESPONSE TO EMERGENCY SITUATIONS.....	5
2.2.1	LEAKING BATTERIES.....	5
2.2.2	FIRE.....	5
2.2.3	WET BATTERIES AND DAMAGED BATTERIES.....	5
2.3	QUALIFIED INSTALLER.....	6
<b>3</b>	<b>PRODUCT INTRODUCTION.....</b>	<b>7</b>
3.1	PRODUCT OVERVIEW.....	7
3.1.1	DIMENSION AND WEIGHT.....	7
3.1.2	APPEARANCE.....	8
3.2	BASIC FEATURES.....	10
3.2.1	FEATURES.....	10
3.2.2	CERTIFICATIONS.....	10
3.3	SPECIFICATIONS.....	11
3.3.1	T-BAT SYS-HV CONFIGURATION LIST.....	11
3.3.2	PERFORMANCE.....	11
<b>4</b>	<b>INSTALLATION.....</b>	<b>12</b>
4.1	INSTALLATION PREREQUISITES.....	12
4.2	SAFETY GEAR.....	12
4.3	TOOLS.....	13
4.4	INSTALLATION.....	13
4.4.1	CHECK FOR TRANSPORT DAMAGE.....	13
4.4.2	UNPACKING.....	13
4.4.3	ACCESSORIES.....	14
4.4.4	INSTALL BMS TO BATTERY MODULE.....	16
4.4.5	MOUNTING STEPS.....	17

4.5	CABLE CONNECTION.....	19
4.5.1	CONNECTING POWER CABLES.....	19
4.5.2	CONNECTING RS485 COMMUNICATION CABLE.....	23
4.5.3	CONNECTING CAN COMMUNICATION CABLE.....	24
4.5.4	CONNECTING GROUND WIRE.....	25
4.5.5	CONNECTING CHARGING CABLE.....	26
4.6	OVERVIEW OF INSTALLATION.....	28
<b>5</b>	<b>COMMISSIONING.....</b>	<b>29</b>
5.1	CONFIGURING BATTERY SYSTEM.....	29
5.2	COMMISSIONING.....	31
5.3	STATUS INDICATORS.....	32
5.3.1	BMS (MC0500).....	32
5.3.2	BATTERY MODULE (HV10045/HV10063).....	33
5.3	SHUTTING DOWN T-BAT SYSTEM.....	33
<b>6</b>	<b>TROUBLESHOOTING.....</b>	<b>32</b>
6.1	TROUBLE SHOOTING.....	34
<b>7</b>	<b>DECOMMISSIONING.....</b>	<b>36</b>
7.1	DISMANTLING THE BATTERY.....	36
7.2	PACKAGING.....	36

## 1 Note on this Manual

### 1.1 Scope of Validity

This manual is an integral part of T-BAT Series. It describes the assembly, installation, commissioning, maintenance and failure of the product. Please read it carefully before operating.

#### T-BAT BMS

MC0500 (Master Box)

#### T-BAT Module-HV

HV10045 (T45)

HV10063(T63)

Note: There are 8 models for T-BAT system, which includes BMS and battery module(s). Please refer to section 3.3.1 **T-BAT SYS-HV Configuration List** on page 11 for detailed models.

### 1.2 Target Group

This manual is for qualified electricians. The tasks described in this manual may only be performed by qualified electricians.

### 1.3 Symbols Used

The following types of safety instructions and general information appear in this document described as below:



**DANGER!**

"DANGER" indicates a hazardous situation which, if not avoided, will result in death or serious injury.



**WARNING!**

"WARNING" indicates a hazardous situation which, if not avoided, could result in death or serious injury.



**CAUTION!**

"CAUTION" indicates a hazardous situation which, if not avoided, could result in minor or moderate injury.



**NOTE!**

"NOTE" provides tips that are valuable for the optimal operation of your product.

## 2 Safety

### 2.1 Safety Instructions

For safety reasons, installers are responsible for familiarizing themselves with the contents of this manual and all warnings before performing installation.

#### 2.1.1 General Safety Precautions

##### **! WARNING!**

Please don't crush or impact the battery, and always dispose it according to the safety regulation.

Observe the following precautions:

- Risks of explosion
  - Do not subject the battery module to strong impacts.
  - Do not crush or puncture the battery module.
  - Do not dispose of the battery module in a fire.
- Risks of fire
  - Do not expose the battery module to temperatures in excess of 60°C.
  - Do not place the battery module near a heat source, such as a fireplace.
  - Do not expose the battery module to direct sunlight.
  - Do not allow the battery connectors to touch conductive objects such as wires.
- Risks of electric shock
  - Do not disassemble the battery module.
  - Do not touch the battery module with wet hands.
  - Do not expose the battery module to moisture or liquids.
- Risks of damage to the battery module
  - Keep the battery module away from children and animals.
  - Do not allow the battery module to get in contact with liquids.
  - Do not subject the battery module to high pressures.
  - Do not place any objects on top of the battery module.

T-BAT SYS-HV can be used only in the household energy field. It is not allowed to be used in other industries, such as the medical equipment and automotive application.





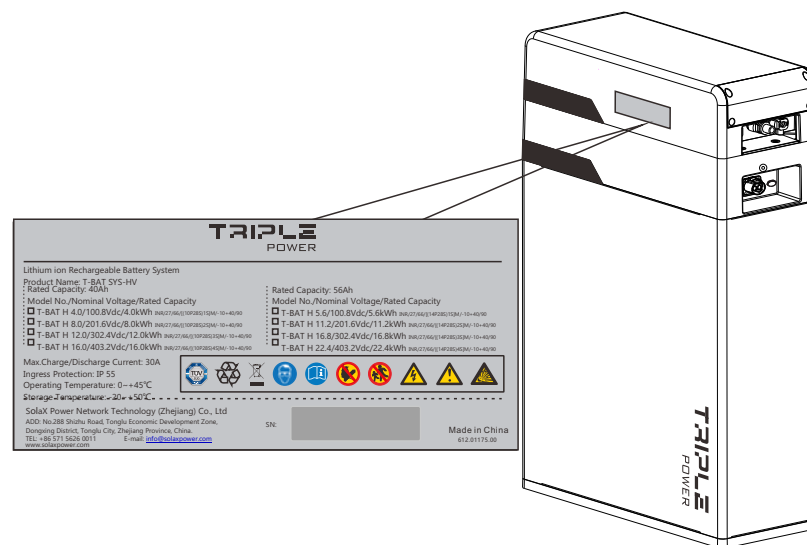





#### 2.1.2 Explanation of Symbols

This section gives an explanation of all the symbols shown on the T-BAT system and on the warning label.



##### **! CAUTION!**

If the battery is not installed within one month after receiving the battery, the battery must be charged for maintenance.

Symbol	Explanation
	TUV mark for IEC62619
	The battery system should be disposed of at a proper facility for environmentally safe recycling.
	The battery system should not be disposed together with the household waste. Disposal information can be found in the enclosed documentation.
	Wear protective glasses
	Observe enclosed documentation.
	Keep the battery system away from open flames or ignition sources.
	Keep the battery system away from children.
	Danger of high voltages. Danger to life due to high voltages in the battery system!
	Danger. Risk of electric shock!
	The battery module may explode.

## 2.2 Response to Emergency Situations

### 2.2.1 Leaking Batteries

If the battery leaks electrolyte which is corrosive, avoid contact with the leaking liquid or gas. Direct contact may lead to skin irritation or chemical burns. If one is exposed to the leaked substance, do these actions:

**Accidental inhalation of harmful substances:** Evacuate people from the contaminated area, and seek medical attention immediately.

**Eye contact:** Rinse eyes with flowing water for 15 minutes, and seek medical attention immediately.

**Dermal contact:** Wash the affected area thoroughly with soap and water, and seek medical attention immediately.

**Ingestion:** Induce vomiting, and seek medical attention immediately.

### 2.2.2 Fire

In case of a fire, make sure an ABC or carbon dioxide extinguisher is nearby.



#### WARNING!

The battery module may catch fire when heated above 150°C.

If a fire breaks out where the battery module is installed, do these actions:

1. Extinguish the fire before the battery module catches fire;
2. If the battery module has caught fire, do not try to extinguish the fire. Evacuate people immediately.

#### WARNING!

If the battery module catches fire, it will produce noxious and poisonous gases. Do not approach.

### 2.2.3 Wet Batteries and Damaged Batteries

If the battery module is wet or submerged in water, do not try to access it. If the battery module seems to be damaged, they are not fit for use and may pose a danger to people or property.

Please pack the battery in its original container, and then return it to SolaX or your distributor.

#### CAUTION!

Damaged batteries may leak electrolyte or produce flammable gas. If you suspect such damage, immediately contact SolaX for advice and information.

## 2.3 Qualified Installer

### **⚠ WARNING!**

All operations of T-BAT SYS-HV relating to electrical connection and installation must be carried out by qualified personnel.

A skilled worker is defined as a trained and qualified electrician or installer who has all of the following skills and experience:

- Knowledge of the functional principles and operation of on-grid systems
- Knowledge of the dangers and risks associated with installing and using electrical devices and acceptable mitigation methods
- Knowledge of the installation of electrical devices
- Knowledge of and adherence to this manual and all safety precautions and best practices

## 3 Product Introduction

### 3.1 Product Overview

Triple power battery is a series of High Voltage Lithium-ion battery. It is designed for residential and commercial energy storage system.

#### 3.1.1 Dimension and Weight

A battery management system (BMS) is any electronic system that manages a rechargeable battery.

Battery module is a type of electrical battery which can be charged, discharged into a load.

A battery system includes BMS and battery module(s).

	MC0500	HV10045	HV10063
<b>Length</b>	461mm	464mm	464mm
<b>Width</b>	189mm	193mm	193mm
<b>Height</b>	105mm	588mm	588mm
<b>Weight</b>	5.7kg	56.6kg	67.5kg

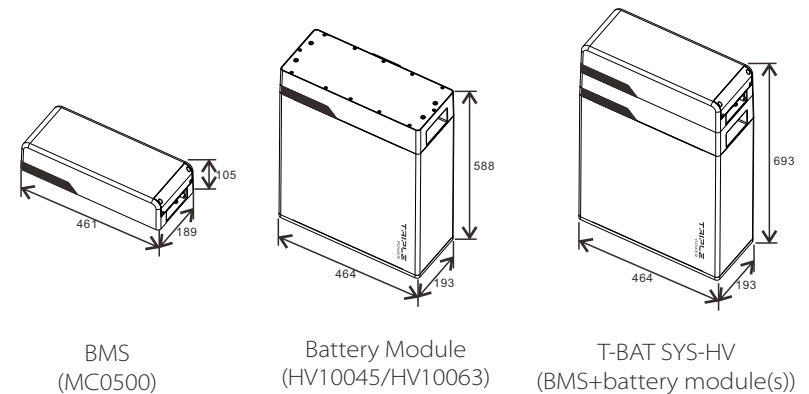

### 3.1.2 Appearance

- Section view of MC0500

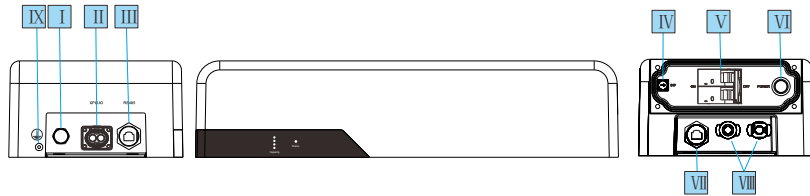

Object	Mark	Description
I	/	Air Valve
II	XPLUG	Power Connector
III	RS485	RS485 Connector
IV	DIP	DIP Switch
V	ON/OFF	Circuit Breaker
VI	POWER	Power Button
VII	CAN	CAN Connector
VIII	BAT+/BAT-	Charge/Discharge Connectors
IX	GND	GND

- Section view of HV10045/HV10063

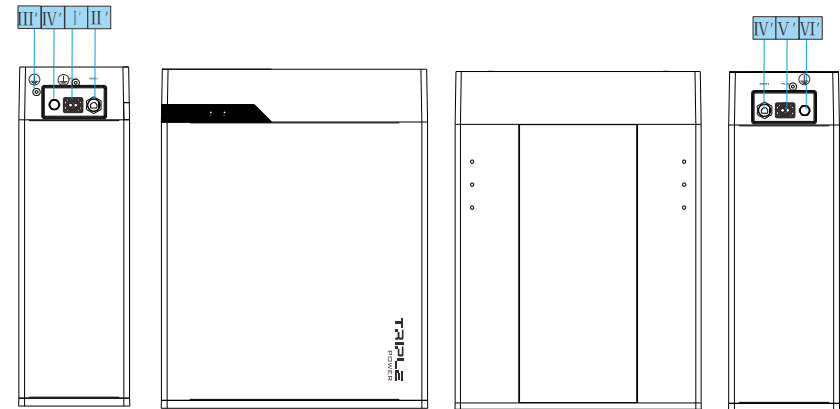

Object	Mark	Description
I'	XPLUG	Power Connector to BMS, or YPLUG of upper battery module
II'	RS485 I	RS485 Connector to BMS, or RS485 II of upper battery module
III'	GND	GND
IV'	RS485 II	RS485 Connector to RS485 I of next battery module
V'	YPLUG	Power Connector to XPLUG of next battery module
VI'	/	Air valve

## 3.2 Basic Features

### 3.2.1 Features

The T-BAT SYS-HV is one of the advanced energy storage systems on the market today, incorporating state-of-the-art technology, high reliability, and convenient control features shown as below:

- 90% DOD
- 99% Faradic charge efficiency
- 95% Battery roundtrip efficiency
- Cycle life > 6000 times
- Secondary Protection by hardware
- IP55 protection level
- Safety & Reliability
- Small footprint
- Floor or wall mounting

### 3.2.2 Certifications

T-BAT system safety	CE, FCC, RCM, TUV (IEC 62619), UL 1973
Battery cell safety	UL 1642
UN number	UN 3480
Hazardous materials classification	Class 9
UN transportation testing requirements	UN 38.3
International protection marking	IP 55

## 3.3 Specifications

### 3.3.1 T-BAT SYS-HV Configuration List

No.	Model	BMS	Battery Module	Energy(kWh)	Voltage (V)
1	T-BAT H4.5	MC0500x1	HV10045X1	4.5	85-118
2	T-BAT H9.0	MC0500x1	HV10045X2	9	170-236
3	T-BAT H13.5	MC0500x1	HV10045X3	13.5	255-354
4	T-BAT H18.0	MC0500x1	HV10045X4	18	340-472
5	T-BAT H6.3	MC0500x1	HV10063X1	6.3	85-118
6	T-BAT H12.6	MC0500x1	HV10063X2	12.6	170-236
7	T-BAT H18.9	MC0500x1	HV10063X3	18.9	255-354
8	T-BAT H25.2	MC0500x1	HV10063X4	25.2	340-472

### 3.3.2 Performance

	MC0500	HV10045	HV10063
Nominal Voltage(Vdc)	/	100.8	100.8
Operating Voltage(Vdc):	70-500	85-118	85-118
Nominal Capacity(Ah):	/	45	63
Max. charge/discharge Current(A) :	30	30	30
Recommend Charge/Discharge Current (A):	25	25	25
Standard Power(kW)	/	2.5	2.5
Maximum Power(kW)	/	3	3
Faradic Charge Efficiency(25°C/77°F)	99%		
Battery Roundtrip Efficiency(C/3, 25°C/77°F)	95%		
Expected Lifetime(25°C/77°F)	5 years		
Cycle life(100% DOD, 25°C/77°F)	6000 cycles		
Available Operating Temperature	0-45 °C		
Optimal Operating Temperature	15°C-30°C		
Storage Temperature	-20°C--45°C (3 months)		
	-20°C--20°C (1 year)		
Ingress Protection	IP55		



## 4 Installation

### 4.1 Installation Prerequisites

Make sure that the installation location meets the following conditions:

- The building is designed with resistance to earthquakes
- The location is far away from the sea, to avoid sea water and humid air
- The floor is flat and level
- There are no flammable or explosive materials nearby
- The ambience is shady and cool, keep away from heat and avoid direct sunlight.
- The temperature and humidity stays at a constant level.
- There is minimal dust and dirt in the area.
- There is no corrosive gases present, including ammonia and acid vapor.
- The ambient temperature is within the range from 0°C to 45°C, and the optimal ambient temperature is between 15°C and 30°C.

#### NOTE!

The Triple Power battery module is rated at IP55 and thus can be installed outdoors as well as indoors. However, for outdoor installation, do not expose the battery directly to sunlight or moisture.

#### NOTE!

If the ambient temperature is beyond the operating range, the battery will stop operating to protect itself. The optimal temperature range for the battery to operate is from 15°C to 30°C. Frequent exposure to harsh temperatures may deteriorate the performance and lifetime of the battery module.

### 4.2 Safety Gear

Installation and maintenance personnel must operate according to applicable federal, state and local regulations as well as the industry standard. The product installation personnel shall wear safety gears, etc in order to avoid short circuit and personal injury.



Insulated gloves



Safety goggles



Safety shoes

### 4.3 Tools

These tools are required to install the T-BAT system.



Torque screwdriver



Phillips screwdriver

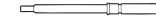

Hexagon wrench



Phillips screwdriver



Slotted screwdriver



Torque wrench

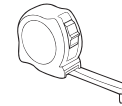

Tape measure



Driller



Pencil or Marker

### 4.4 Installation

#### 4.4.1 Check for Transport Damage

Make sure the battery is intact during transportation. If there are some visible damages, such as cracks, please contact your dealer immediately.

#### 4.4.2 Unpacking

Unpacking the battery package by cutting the packing tape and make sure the battery modules and the relevant items are complete. See package items on section 4.4.3, please check the packing list carefully, if there's any item missing, please contact SolaX or your distributor directly.

#### CAUTION!

According to regional regulations, several people may be required for moving the equipment.

#### WARNING!

Please strictly follow the installation steps. SolaX will not be responsible for any hurting or loss caused by incorrect assembling and operation.

### 4.4.3 Accessories

#### BMS (Master Box):

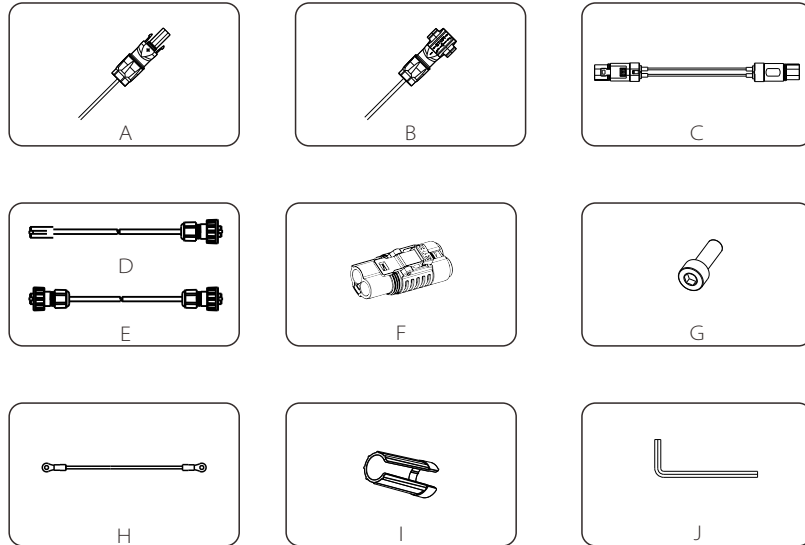

The table below lists the number of each component.

Object	Description	Quantity
A	Battery Power cable (+)	1
B	Battery Power cable (-)	1
C	Power cable between BMS and battery module (120mm)	1
D	CAN communication cable (2m)	1
E	RS485 communication cable (120mm)	1
F	Short-circuit plug	1
G	M5 screw	4
H	Ground wire	1
I	Rotation wrench	1
J	L-type wrench	1

#### Battery Module (T45/T63):

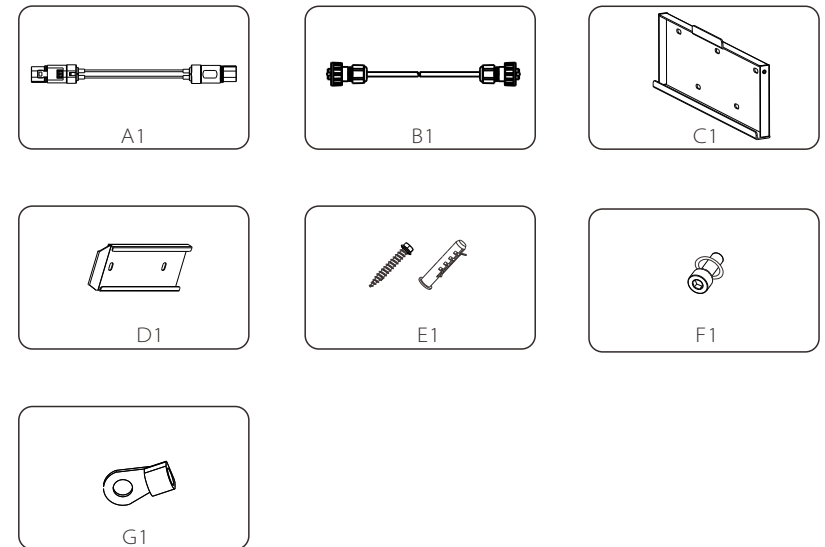

Object	Description	Quantity
A1	Power cable between battery modules (400mm)	1
B1	RS485 communication cable (400mm)	1
C1	Wall mounting bracket	1
D1	Floor mounting bracket	1
E1	Expansion bolt	5
F1	M6 screw	1
G1	Ring terminal (for grounding)	2

#### 4.4.4 Install BMS to Battery Module

Install the BMS on the battery module. Fix it with M5 screws on holes shown as below with L-type Wrench(J). Please pay attention to the correct direction of BMS and battery modules, and put the same side of BMS and battery modules at front.

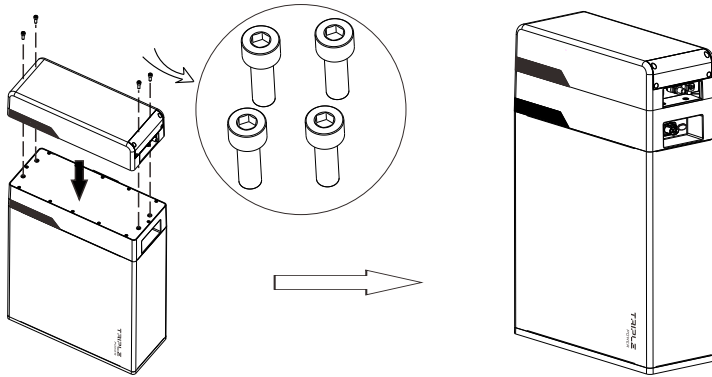

#### CAUTION!

Make sure that the system is always exposed to the ambient air. The system is cooled by natural convection. If the system is entirely or partially covered or shielded, it may cause the system to stop operating. Please estimate the length of grounding cable first, because the ground port is designed at the back side of BMS and battery module. Please refer to section **4.5.4 Connecting Ground Wire** for more information.

#### CAUTION!

There are two mounting options: floor mounting and wall mounting. Customers can choose either option according to the needs. However, if you decide to change to the other option after starting the installation, you have to find the appropriate expansion bolts suitable for the other mounting mode. Floor mounting or wall mounting is a mandatory requirement for installation. Wrong cable connection might occur if the battery modules are not in a row with the front panel in the same side. Finish the floor mounting or wall mounting before connecting cables.

#### 4.4.5 Mounting Steps

It is recommended that the space between battery modules is more than 250mm.

##### Floor Mounting

Step 1: Fix the floor mounting bracket (D1) on the wall.

- The distance between the bottom of the battery module and the lower hole of the bracket is 375mm, measure it and mark the position of the two holes.
- Drill holes with a  $\phi 10$  drill bit, make sure the holes are deep enough (at least 50mm) for installation and then hammer the expansion tubes into the holes.
- Install the expansion screws(E1) in the wall, and screw the bracket(D1) by using a screwdriver.

Step 2: Remove the lower hanging board at the back of the battery which has been installed already.

Step 3: Lift the battery module up and move the battery module close to the bracket, and then match it to complete the floor mounting.

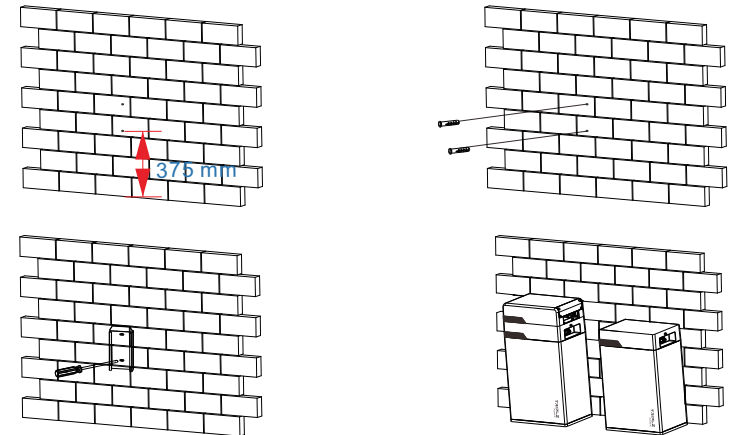

The following figure is the back view of floor mounting.

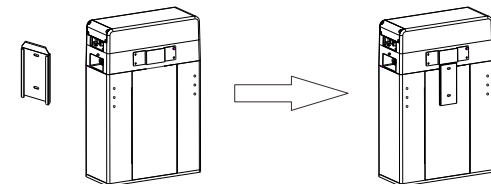

**Wall mounting:**

Make sure the wall is strong enough to withstand the weight of battery modules.

Step 1: Fix the wall mounting bracket (C1) on the wall

- Use the wall bracket as a template to mark the position of the 5 holes.
- Drill holes with a  $\phi 10$  drill bit, make sure the holes are deep enough(at least 50mm) for installation and then hammer the expansion tubes into the holes.
- Install the expansion screws(E1) in the wall, and screw the wall bracket(C1) by using a screwdriver.

Step 2: Remove the upper hanging board which has been installed already.

Step 3: Lift the battery module up and move the battery module close to the bracket, and then match it on the wall bracket.

Step4: Lock the joint between hanging board and wall bracket with M5 combination screw(F1).

**Note: Keep the distance from installation point to the floor less than 1m.**

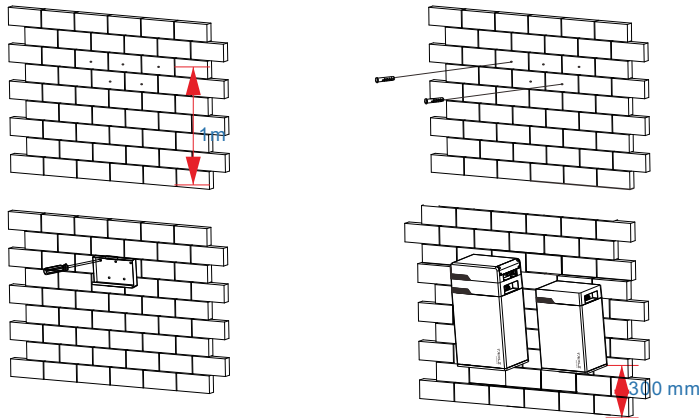

The following figure is the back view of wall mounting.

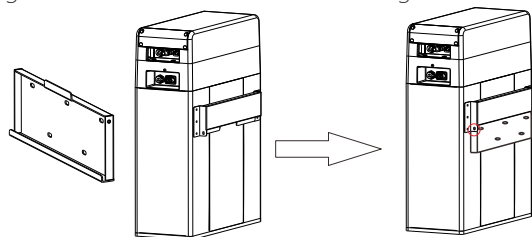

**4.5 Cable Connection**

**4.5.1 Connecting Power Cables**

**For one battery module:**

The color at both end of the power cable between BMS and battery module is orange. The power cable will be connected to XPLUG which is at one side of the BMS (IV) and the battery module (I').

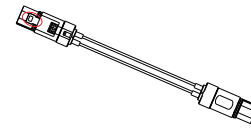

1. Plug either end of the 120mm power cable into the XPLUG port on BMS, and the other end into the XPLUG port on battery module. When the metal sheet which is marked in red is totally inserted and a click sound is heard, that means the power cable is properly connected.

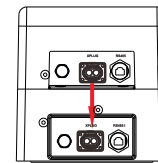

2. Please make sure that both ends of the power cable are connected to the correct connector, which are on the left side of BMS and battery module that shown in the figure.

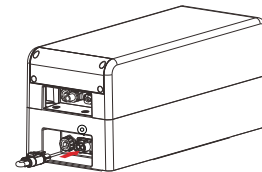

3. Once finished, please connect the short-circuit plug to the YPLUG port on battery module(V') to complete the internal circuit.

Overview of Step 2 and Step3:

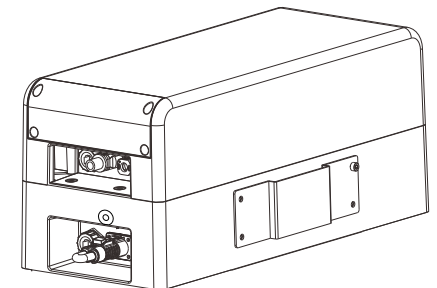
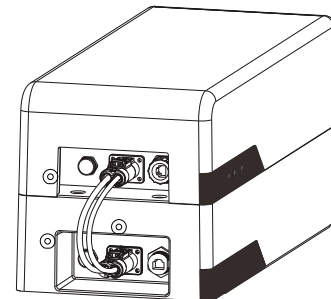

**Notes for Unplugging Power Cables**

**⚠ CAUTION!**

DO NOT plug/unplug power cables when the T-BAT system is not turned off, otherwise there will be an arc discharge that could cause serious injury!

1. Shut down the T-BAT system (Please refer to **Section 5.4 Shutting Down T-BAT System** of User Manual on Page 33);
2. Remove the lock cover
  - a. Pull at back end of the lock cover with finger or an instrument;
  - b. Remove the lock cover and keep it for next time.

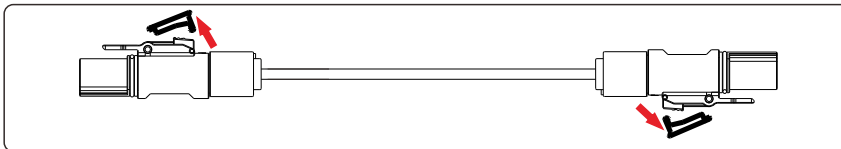
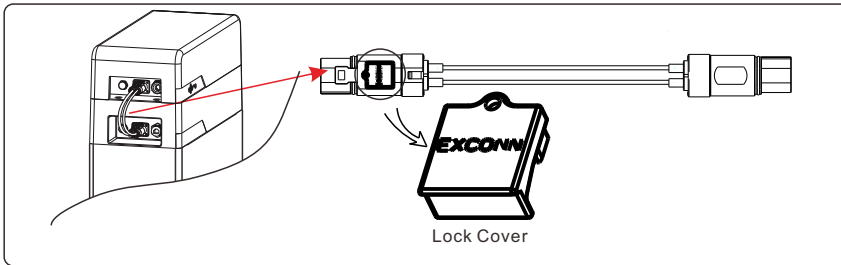

3. Push the plastic button on each end of the power cable in the direction of the arrow;
4. Unplug the power cable.

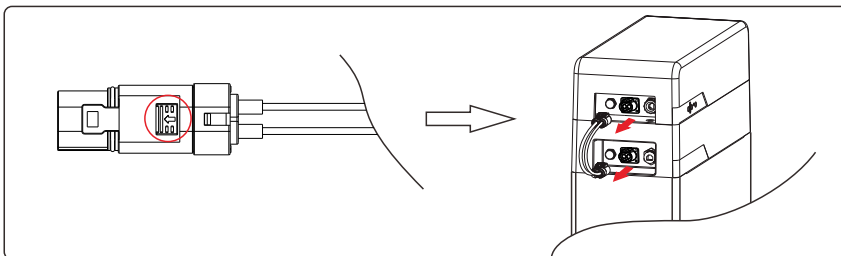

**For 2~4 battery modules:**

The power cable between battery modules (A1) is different from the one that between BMS and battery module ©. The other end of the power cable is black, and this color is connected to YPLG (V'), which is on the right side of the battery module.

1. Plug one end of the 400mm power cable into the YPLUG port (V') on the first battery module, and the other end into the XPLUG port on the next battery module( I ). Repeat the same step on all the battery modules. The following figure shows how the four battery modules are connected.

**⚠ NOTE!**

Make sure that GND has been finished before the cable connection!

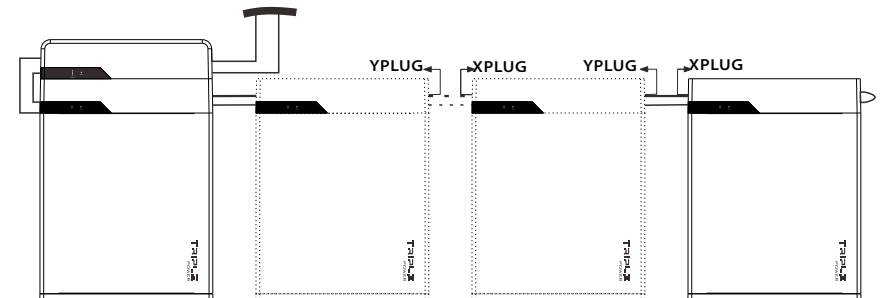
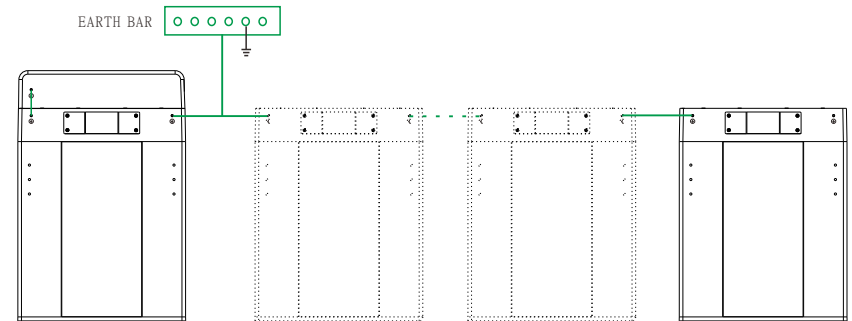

2. After all the battery modules were correctly connected, plug the short-circuit plug (F) at YPLUG (V) of last battery module to make a complete circuit.

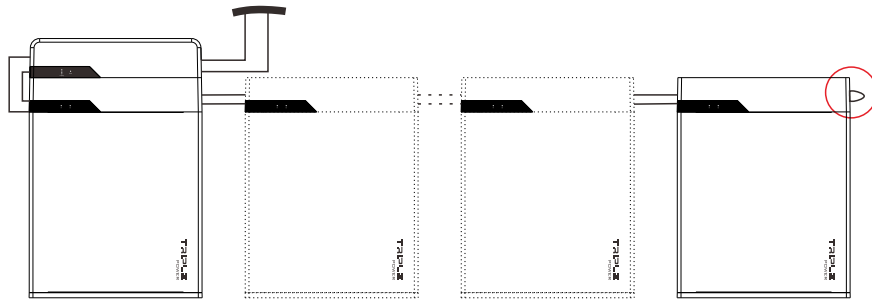

**⚠ Danger!**

Touch the two sheetmetals of the power connector will get an electric shock, DO NOT touch them! Also DO NOT connect XPLG to YPLG on the same battery module!

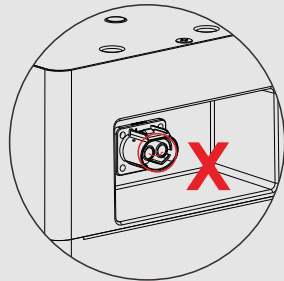

**4.5.2 Connecting RS485 Communication Cable**

**For one battery module:**

1. There's a protective cap for the RS485 connector, unscrew the cap and plug one end of the RS485 communication cable to the RS485 connector on BMS. Tighten the plastic screw cap with rotation wrench(I).
2. Connect the RS485 communication cable (E) from BMS (III) to the RS485 I communication port (II') on the battery module. The communication ports are marked in the following figure.

**For 2~4 battery modules:**

Follow the same steps as the above.

Then Connect RS485 II (IV') of first battery module to RS485 I (II') of the next battery module. Repeat the same step to connect the rest battery modules.

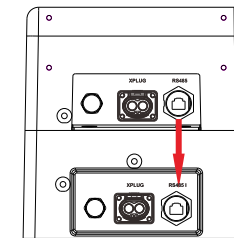

The wiring order of the communication cable is as follows:

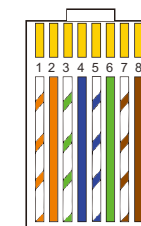
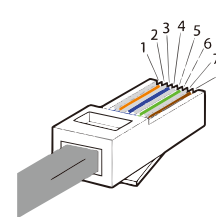

- 1) White with an orange stripe
- 2) Orange
- 3) White with a green stripe
- 4) Blue
- 5) White with a blue stripe
- 6) Green
- 7) White with a brown stripe
- 8) Brown

Sequence	1	2	3	4	5	6	7	8
<b>RS485I</b>	VCC_485	GND_485	B2	N-	P+	A2	VCC_485_2	GND_485
<b>RS485II</b>	VCC_485	GND_485	B2	N-	P+	A2	VCC_485_2	GND_485

### 4.5.3 Connecting CAN Communication Cable

It is required for the BMS to communicate with the inverter for proper operation.

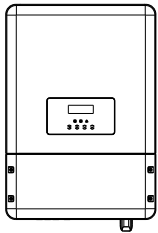

1. Turn off the Inverter, insert one end of the CAN communication cable (D) to the BMS port on the Inverter. Assemble the cable gland and tighten it.

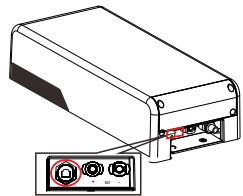

2. There's a protect cap for the CAN connector on BMS, unscrew the cap.

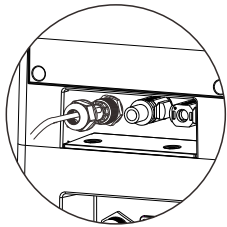

3. Plug the other end of the CAN communication cable to the CAN connector on BMS. Tighten the screw cap at the end of the cable.

The wire order of the communication cable is the same as RS485 communication cable

Sequence	1	2	3	4	5	6	7	8
<b>CAN</b>		GND		CAN_H	CAN_L		A1	B1

### 4.5.4 Connecting Ground Wire

#### For one battery module:

Unscrew the ground terminal with hexagon wrench on BMS and battery module at either side of the ground port as marked at the following figure. Connect the ground wire from BMS to battery module.

Note: 10AWG ground wire is required for grounding.

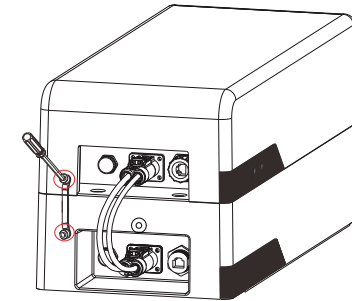

#### For 2~4 battery modules:

The GND connection between BMS and battery module is the same as described above.

The terminal point for GND connection between battery modules are circled in red below:

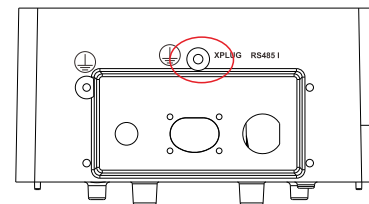

Left side of battery module

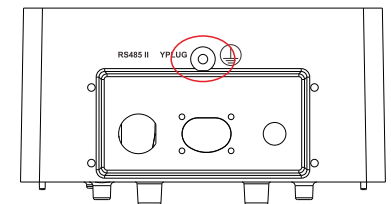

Right side of battery module

#### CAUTION!

GND connection is mandatory!

#### 4.5.5 Connecting Battery Power Cables

This step is to connect battery power cables between Inverter and T-BAT system.

The length of the cables are 2 meters, so you can appropriately cut the cable according to the actual installation environment. Please note, each cable has only one terminal block ready when leaving the factory, and you need to connect the other end of the cable by yourself.

##### ➤ Cable Connection Steps:

**Step1.** Strip the cable to 15mm.

**Step2.** Insert the stripped cable up to the stop (negative cable for DC plug(-) and positive cable for DC socket(+) are live). Hold the housing on the screw connection.

**Step3.** Press down the spring clamp until it clicks into place.  
(You should be able to see the fine wire strands in the chamber)

**Step4.** Tighten the screw connection (Tightening torque:  $2.0 \pm 0.2 \text{ Nm}$ )

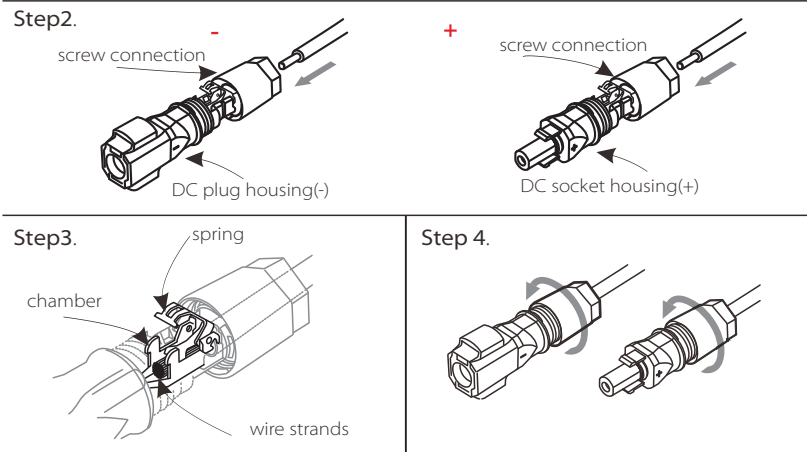

##### ➤ Connecting Battery Power Cables between Inverter and BMS:

1. Connect the battery power cables between Inverter and BMS. Please pay attention to connect the cables (+,-) to the correct BAT port on both the Inverter and BMS.

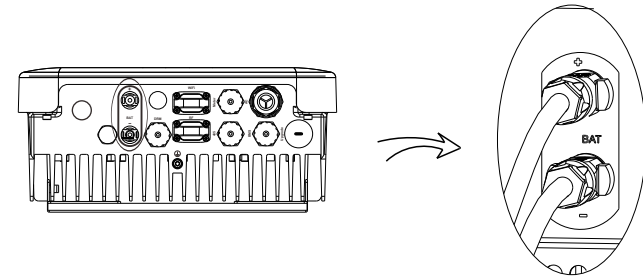

2. Connect the negative cable (-) (B) to the port on the right and the positive cable (+) (A) to the one on the left shown as in the figure.

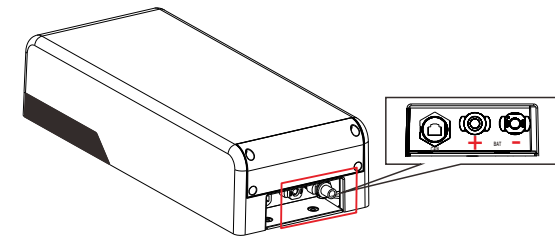

##### 👉 NOTE!

1. When connecting the cable to Inverter, fit the two connectors together until the connection audibly locks into place.
2. Check to make sure the connection is securely locked.
3. Don't shake both ends of the cable at the joint once the connection is locked.



## 4.6 Overview of Installation

The following diagram is a complete T-BAT system installation with four battery modules.

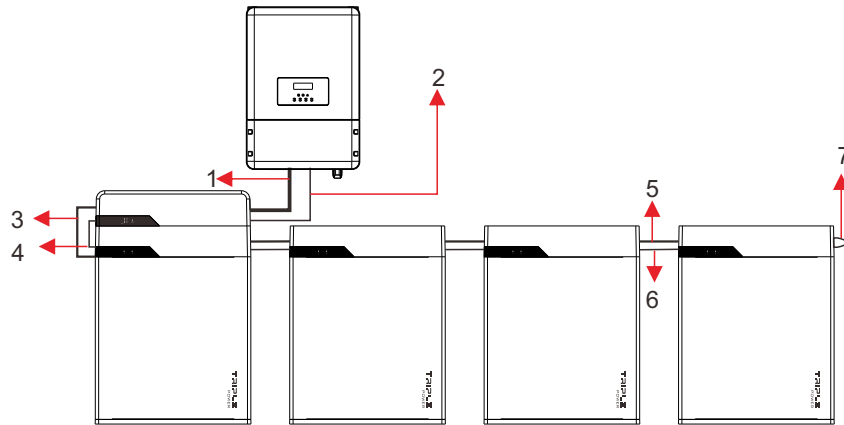

- 1: Battery Power Cable
- 2: CAN Communication Cable
- 3: Power Cable between BMS and battery module (120mm)
- 4: RS485 Cable between BMS and battery module (120mm)
- 5: Power Cable between battery modules (400mm)
- 6: RS485 Cable between battery modules (400mm)
- 7: Short-circuit plug

### DANGER!

One T-BAT system is allowed to install at most four battery modules. Connecting more than four battery modules will blow the fuse, and the battery module will be damaged. Please make sure the number of battery modules meets the requirement.

## 5 Commissioning

### 5.1 Configuring Battery System

The DIP switch is used to configure the number of battery modules which are communicating to Inverter. The detailed configuration information is shown as follows:

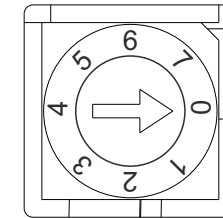

Configuration activated by inverters

- 0- Matching one battery module (default)
- 1- Matching two battery modules
- 2- Matching three battery modules
- 3- Matching four battery modules

Black-start configuration

The black-start function is only used in the off-grid environment and there is no other power supply.

**Note: If the battery is powered ON in black-start mode, the BAT port still has high voltage and there is a risk of electric shock, even when there is no BMS connection!**

After the black-start mode starts, if the BMS communication can not be built within 3 minutes, the black start will stop immediately.

- 4- Matching one battery module
- 5- Matching two battery modules
- 6- Matching three battery modules
- 7- Matching four battery modules

**NOTE!**

When powering on the BMS, the system will start self-test. If the buzzer bips, it means DIP configuration fault or communication failure occurs. In this case, please press the POWER button to turn it OFF, then check if the number of battery modules is corresponding to the DIP configuration, and also check if the RS485 communication cables are correctly connected. After checking all these, press the POWER button to power it back on. In addition: The buzzer will only alarm on the corresponding fault during the power-on self-test. When the self-test is completed, it won't bip again even if the same fault occurs.

**5.2 Commissioning**

Verify the model number of each battery module to make sure that they are all the same model.

If all the battery modules are installed, follow these steps to put it in operation.

1. Remove the cover board of BMS;
2. Rotate the DIP (IV) to corresponding number with small tool according to the number of battery module(s) that has(have) been installed;
3. Move the circuit breaker (V) to the ON position;
4. Press the POWER button (VI) to turn on the T-BAT system;
5. Reinstall the cover board to BMS;
6. Power on the Inverter.

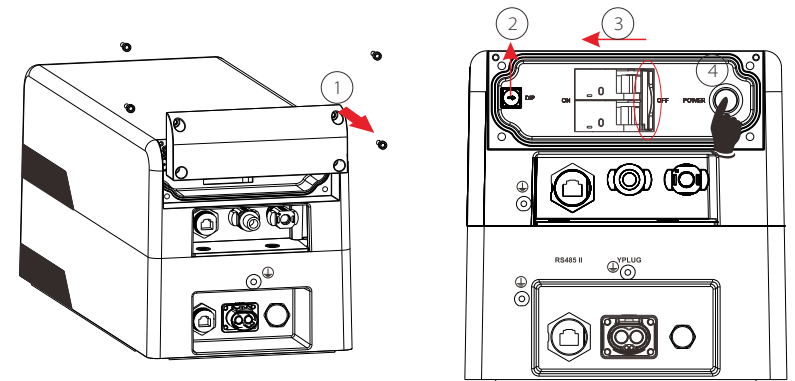
**NOTE!**

Frequently press the POWER button may cause the system error. Please make sure at least 10 seconds is needed when you are going to press the POWER button from the last pressing operation.

### 5.3 Status Indicators

The LED indicators on the front panel of the BMS and battery modules are showing the operating status.

#### 5.3.1 BMS (Master Box)



The following table shows the status of BMS.

No.	Status of BMS	Mode
1	Green LED flashes once every 5s	Active
2	Yellow LED flashes once every 5s	Warning
3	Red LED flashes once every 5s	Protection
4	Green LED keeps on	Configuring
5	Green LED flashes quickly	Upgrade for BMS

The capacity indicators show the SOC:

- When the battery module is neither charging nor discharging, the indicator lights off.
- When the battery module is charging, part of the blue LED flashes once every 5s, and part of the blue LED keeps on. Take SOC 60% for instance, in charging state:
  1. The last two blue LED indicators keeps on
  2. The last third blue LED indicator flashes once every 5s
- When the battery module is discharging, the blue LED indicators flash once every 5s. Take SOC 60% for instance, in discharging state:
  1. The last three blue LED indicators flash once every 5s



Charging

Discharging

#### 5.3.2 Battery Module (T45/T63)



S1 and S2 represent independent status indicators. The status of S1 and S2 have the same meaning for battery module in the following table.

Note: only when both S1 and S2 are flashing once every 5s in Green LED, it means the battery system is active.

No.	Status of battery module	Mode
1	Green LED flashes once every 5s	Active
2	Yellow LED flashes once every 5s	Protection
3	Red LED flashes once every 5s	Fault
4	Green LED flashes quickly	Upgrade for BMS

#### NOTE!

After powering off the BMS, the LED lights of S1 and S2 will keep flashing for 20 minutes.

### 5.4 Shutting Down T-BAT System

To shut down the system, follow the steps described below:

1. Turn off the breaker between Inverter and T-BAT System;
2. Power off the BMS;
3. Turn off the system by moving the circuit breaker switch to the OFF position;
4. Make sure that every indicator on the T-BAT system is off;
5. Disconnect the cables.

## 6 Troubleshooting

### 6.1 Troubleshooting

Check the indicators on the front to determine the state of the T-BAT system. A warning state is triggered when a condition, such as with voltage or temperature, is beyond design limitations. The T-BAT system's BMS periodically reports its operating state to the inverter.

When the T-BAT system falls outside prescribed limits, it enters a warning state.

When a warning is reported, the inverter immediately stops operation.

Use the monitoring software on the inverter to identify what caused the warning.

The possible warning messages are as follows:

Warning Messages	Description	Troubleshooting
BMS_External_Err	The communication between BMS and Inverter is interrupted	Check if the communication cable between BMS and Inverter is correctly and well connected.
BMS_Internal_Err	1. DIP switch at the wrong position; 2. The communication between battery modules is interrupted	1. Move the DIP switch to the correct position; 2. Check if the communication cable between battery modules is correctly and well connected.
BMS_OverVoltage	Battery over voltage	Please contact SolaX after-sales service or your distributor directly.
BMS_LowerVoltage	Battery under voltage	Please contact SolaX after-sales service or your distributor directly.
BMS_ChargeOCP	Battery charge over current protection	Please contact SolaX after-sales service or your distributor directly.
BMS_DischargeOCP	Battery discharge over current protection	Please contact SolaX after-sales service or your distributor directly.

Warning Messages	Description	Troubleshooting
BMS_TemHigh	Battery over temperature	Wait till the temperature of cells go back to the normal state.
BMS_TemLow	Battery under temperature	Wait till the temperature of cells go back to the normal state.
BMS_CellImblance	The capacities of cells are different	Please contact SolaX after-sales service or your distributor directly.
BMS_Hardware_Protect	Battery hardware under protection	Please contact SolaX after-sales service or your distributor directly.
BMS_Insulation_Fault	Battery insulation fault	Please contact SolaX after-sales service or your distributor directly.
BMS_VoltSensor_Fault	Battery voltage sensor fault	Please contact SolaX after-sales service or your distributor directly.
BMS_TempSensor_Fault	Battery temperature sensor fault	Please contact SolaX after-sales service or your distributor directly.
BMS_CurrSensor_Fault	Battery current sensor fault	Please contact SolaX after-sales service or your distributor directly.
BMS_Relay_Fault	Battery relay fault	1. Make sure the power cable is correctly and well connected to the power connector (XPLUG) of the BMS; 2. If the first step still does not work, please contact SolaX after-sales service or your distributor directly.
BMS_Type_Unmatch	The type of BMS unmatched	Please contact SolaX after-sales service or your distributor directly.
BMS_Ver_Unmatch	The version of BMS unmatched	Please contact SolaX after-sales service or your distributor directly.

## **7 Decommissioning**

### **7.1 Dismantling the Battery**

Shutting down T-BAT system

Disconnect the cables between BMS and Inverter

Disconnect the short-circuit plug on the last battery module

Disconnect the other cables.

### **7.2 Packing**

Please pack the BMS and battery modules with the original packaging.

If it is no longer available, you can also use an equivalent carton that meets the following requirements.

- Suitable for loads more than 70kg
- With handle
- Can be fully closed